

GALILEO 3

MAIN CHARACTERISTICS

Applications	Street and architectural lighting.
Optic	ASP/ASC: Asymmetrical optics for floodlighting. Colour temperature: 4000K (3000K optional), CRI ≥ 70 Photobiological safety class: EXEMPT GROUP LED source efficiency: 168 lm/W @ 525mA, Tj=85°C, 4000K
Insulation class	I
Protection degree	IP66 IK08
LED Modules	Removable / Replaceable optical unit.
Tilt Angle	<i>See dimensional drawings section</i>
Dimensions	
Weight	27.3 kg without fixing flanges.
Exposed surface	Side: 0.14m ² - Top: 0.30m ²
Mounting	Mounting with adjustable integrated flange (<i>See available flanges section</i>).
Gear tray	Integrated. Removable.
Operating temp.	-40°C / +50°C (525mA) -40°C / +35°C (700mA)
Storage temp.	-40°C / +80°C
Main reference standards	EN 60598-1, EN 60598-2-3, EN 60598-2-5, EN 62471, EN 55015, EN 61547, EN 61000-3-2, EN 61000-3-3



ELECTRICAL CHARACTERISTICS

Rated voltage	220÷240V 50/60Hz (<i>Standard tolerance +/-10%, other voltages and tolerances upon request</i>)
Power factor	>0,9 (at full load)
Mains connection	Cable H07RN-F nx1.5mm ² Optional: connector M/F IP66/68 for cables max. 2,5mm ² , Ø max. 14mm
Surge protection	Up to 10kV With SPD (optional) 10kV / 10kV CM/DM
SPD (optional)	10kV-10kA, type II, with LED signal and thermo fuse to disconnect load at the end of life.

Control system (options)	F: Fixed power not dimmable. DA: Automatic dimming (virtual midnight) with default profile. DAC: Custom DA profile. FLC: Constant light flux. DB: Dual Power with control wire. WL: Wireless single point communication system. DALI: Digital dimming interface DALI.
---------------------------------	---

Optical unit lifetime (Tq=25°C, 700mA)	>100.000hr L90B10 >100.000hr L90, TM-21
---	--

MATERIALS

Fixing	Galvanized and painted steel.
Heat-sink	Die-cast aluminium UNI EN1706 with low copper content. Powder painted.
Body	
Gear tray body	
Optic	99.85% aluminium with a surface finish in 99.95% with vacuum-sealed deposition. Alluminum grade class A+ (DIN EN 16268)
Screen	Flat tempered glass, 5mm thickness.
Cable gland	Metallic, M20x1,5 – IP68
Gasket	Polyurethane
Colour	Graphite - Cod. 01

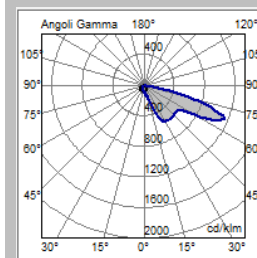

ASP-7W Optic

All the published photometrical data has been obtained according to EN 13032-1

GALILEO 3

DIMENSIONAL DRAWINGS

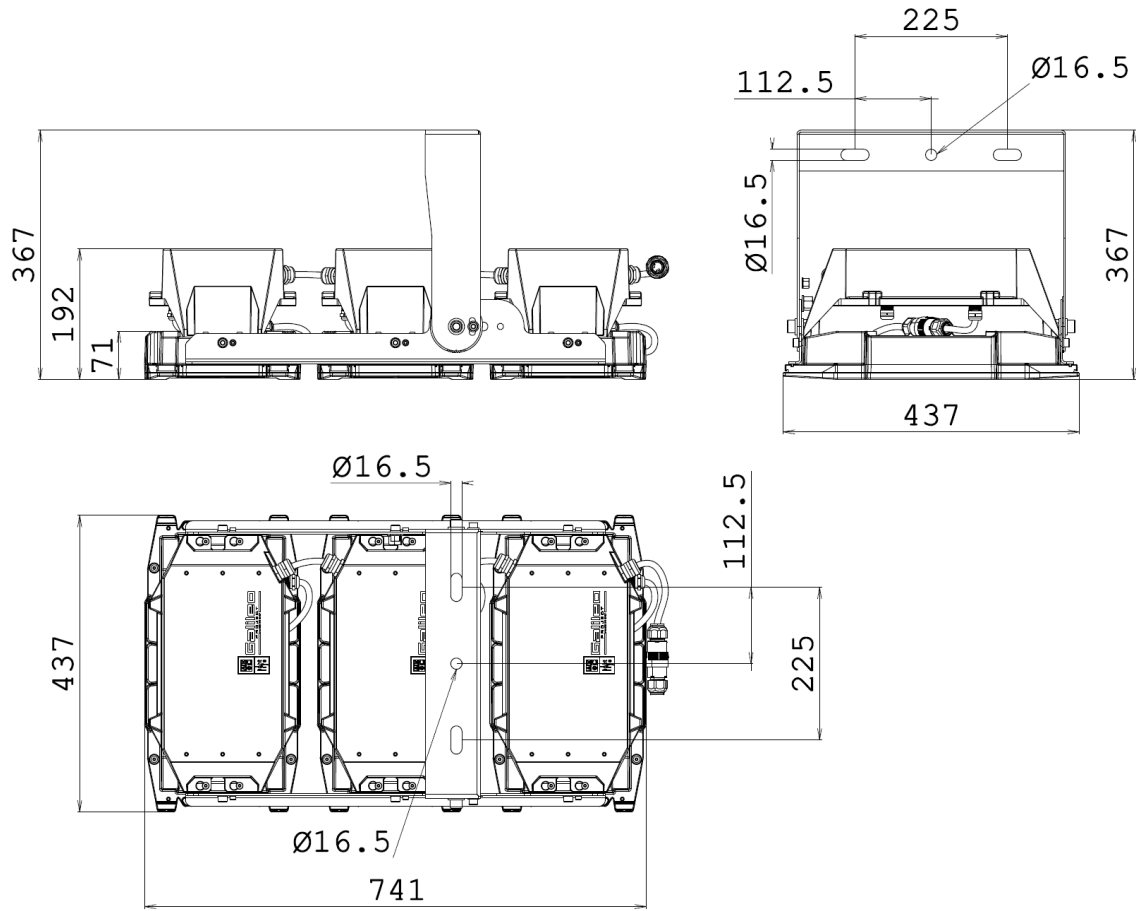

AVAILABLE FIXING FLANGES

BRACKET C – STANDARD

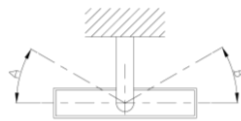

A = 15°
B = 15°

2.3 kg

BRACKET D – OPTIONAL

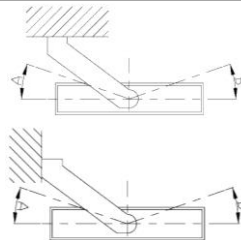

A = 25°
B = 25°

5.3 kg

BRACKET E – OPTIONAL

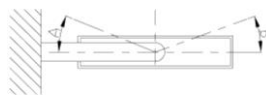

A = 5°
B = 15°

3.3 kg





LUMINAIRE	OPTIC	RATED LUMINAIRE FLUX* (Tq=25°C, 4000K, lm)	RATED LUMINAIRE POWER* (Tq=25°C, Vin=230Vac, F/DA/DAC, W)	LUMINAIRE EFFICACY (Tq=25°C, lm/W)	RATED LED FLUX* (Tj=85°C, 4000K, lm)	RATED LED POWER* (Tj=85°C, W)
Galileo 3 0F6 4.5-7M	ASC-4W	34740	262	132	41307	245
Galileo 3 0F6 4.5-8M	ASP-4N	38440	302	127	47208	280
Galileo 3 0F6 4.5-9M	ASP-4W	43030	336	128	53109	315
Galileo 3 0F6 4.7-7M	ASC-4W	42670	350	121	52290	329
Galileo 3 0F6 4.7-8M	ASP-4N	47130	404	116	59760	376
Galileo 3 0F6 4.7-9M	ASP-4W	52780	450	117	67230	423
Galileo 3 0F6 4.5-7M	ASC-5W	34110	262	130	41307	245
Galileo 3 0F6 4.5-8M	ASP-5N	37890	302	125	47208	280
Galileo 3 0F6 4.5-9M	ASP-5W	42220	336	125	53109	315
Galileo 3 0F6 4.7-7M	ASC-5W	41880	350	119	52290	329
Galileo 3 0F6 4.7-8M	ASP-5N	46470	404	115	59760	376
Galileo 3 0F6 4.7-9M	ASP-5W	51790	450	115	67230	423
Galileo 3 0F6 4.5-7M	ASC-6W	33620	262	128	41307	245
Galileo 3 0F6 4.5-8M	ASP-6N	37350	302	123	47208	280
Galileo 3 0F6 4.5-9M	ASP-6W	41610	336	123	53109	315
Galileo 3 0F6 4.7-7M	ASC-6W	41280	350	117	52290	329
Galileo 3 0F6 4.7-8M	ASP-6N	45810	404	113	59760	376
Galileo 3 0F6 4.7-9M	ASP-6W	51040	450	113	67230	423
Galileo 3 0F6 4.5-7M	ASC-7W	32970	262	125	41307	245
Galileo 3 0F6 4.5-8M	ASP-7N	36800	302	121	47208	280
Galileo 3 0F6 4.5-9M	ASP-7W	41000	336	122	53109	315
Galileo 3 0F6 4.7-7M	ASC-7W	40490	350	115	52290	329
Galileo 3 0F6 4.7-8M	ASP-7N	45130	404	111	59760	376
Galileo 3 0F6 4.7-9M	ASP-7W	50300	450	111	67230	423

*RATED LUMINAIRE FLUX / RATED LUMINAIRE POWER: Rated data obtained in laboratory.

*RATED LED FLUX / RATED LED POWER: Rated data extrapolated from LED manufacturer datasheet.

Values indicated in this technical sheet are to be considered rated values. Flux tolerance: ±7%. Power tolerance: ±5%.

The characteristics of the product listed above are subjected to change without notice.



LUMINAIRE	OPTIC	RATED LUMINAIRE FLUX* (Tq=25°C, 3000K, lm)	RATED LUMINAIRE POWER* (Tq=25°C, Vin=230Vac, F/DA/DAC, W)	LUMINAIRE EFFICACY (Tq=25°C, lm/W)	RATED LED FLUX* (Tj=85°C, 3000K, lm)	RATED LED POWER* (Tj=85°C, W)
Galileo 3 0F6 3.5-7M	ASC-4W	32310	262	123	36330	245
Galileo 3 0F6 3.5-8M	ASP-4N	35750	302	118	41520	280
Galileo 3 0F6 3.5-9M	ASP-4W	40020	336	119	46710	315
Galileo 3 0F6 3.7-7M	ASC-4W	39680	350	113	45990	329
Galileo 3 0F6 3.7-8M	ASP-4N	43830	404	108	52560	376
Galileo 3 0F6 3.7-9M	ASP-4W	49090	450	109	59130	423
Galileo 3 0F6 3.5-7M	ASC-5W	31720	262	121	36330	245
Galileo 3 0F6 3.5-8M	ASP-5N	35240	302	116	41520	280
Galileo 3 0F6 3.5-9M	ASP-5W	39260	336	116	46710	315
Galileo 3 0F6 3.7-7M	ASC-5W	38950	350	111	45990	329
Galileo 3 0F6 3.7-8M	ASP-5N	43220	404	106	52560	376
Galileo 3 0F6 3.7-9M	ASP-5W	48160	450	107	59130	423
Galileo 3 0F6 3.5-7M	ASC-6W	31270	262	119	36330	245
Galileo 3 0F6 3.5-8M	ASP-6N	34740	302	115	41520	280
Galileo 3 0F6 3.5-9M	ASP-6W	38700	336	115	46710	315
Galileo 3 0F6 3.7-7M	ASC-6W	38390	350	109	45990	329
Galileo 3 0F6 3.7-8M	ASP-6N	42600	404	105	52560	376
Galileo 3 0F6 3.7-9M	ASP-6W	47470	450	105	59130	423
Galileo 3 0F6 3.5-7M	ASC-7W	30660	262	117	36330	245
Galileo 3 0F6 3.5-8M	ASP-7N	34220	302	113	41520	280
Galileo 3 0F6 3.5-9M	ASP-7W	38130	336	113	46710	315
Galileo 3 0F6 3.7-7M	ASC-7W	37660	350	107	45990	329
Galileo 3 0F6 3.7-8M	ASP-7N	41970	404	103	52560	376
Galileo 3 0F6 3.7-9M	ASP-7W	46780	450	103	59130	423

*RATED LUMINAIRE FLUX / RATED LUMINAIRE POWER: Rated data obtained in laboratory.

*RATED LED FLUX / RATED LED POWER: Rated data extrapolated from LED manufacturer datasheet.

Values indicated in this technical sheet are to be considered rated values. Flux tolerance: ±7%. Power tolerance: ±5%.

The characteristics of the product listed above are subjected to change without notice.